

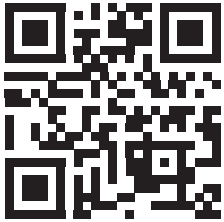





VEHICLE		BAR TYPE		CONNECTOR		BED HEIGHT ADDED (mm/in)		
RAM 1500 Crew Cab w/ RAM BOX DT Gen 5 SHORT BED 5ft7		Reconn-Deck		RTD4		331/13		
VEHICLE NOTES								
REGION	AUS	NZ	USA	CA	SA	UK	EU	ZA
AVAILABILITY	x	x	✓	✓	x	x	x	x
RUNNING DATES	-	-	2019 -	2019 -	-	-	-	-

VISIT THE ONLINE CALCULATOR FOR CURRENT SYSTEM LOAD LIMIT DATA



**DYNAMIC LOAD LIMIT (ON AND OFF-ROAD):**  
 \*USE THE VEHICLE MANUFACTURER'S MAXIMUM TRACK ALLOWANCE IF IT IS LOWER THAN THE FIGURE LISTED

 CARGO UP TO <b>137 Kg</b> <b>303 lbs</b>	 SYSTEM WEIGHT <b>13 Kg</b> <b>28 lbs</b>	 LOAD LIMIT UP TO <b>150 Kg</b> <b>331 lbs</b>	  <b>*VEHICLE MANUFACTURER'S TRUCK BED UTILITY TRACK LOAD LIMIT</b>
---	---	---	--

**TOTAL STATIC LOAD LIMIT: UP TO 375kg / 827lbs**

## BASE

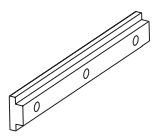
TRACK NUTS	PART DETAILS	
	<b>PART NO</b>	RD-FK3
	<b>KIT QTY</b>	1

## BAR

CROSS BAR	PART DETAILS	
	<b>PART NO</b>	RDB126
	<b>QTY</b>	2

## ACCESSORY

NS BAR	PART DETAILS	
	<b>PART NO</b>	-
	<b>QTY (pair)</b>	-
Recommended NS Bar setup is included in the SYSTEM WEIGHT above. Refer to NS BAR Instructions for custom setups.		

ONLY COMPATIBLE WITH RECONN-DECK BARS

## RECOMMENDED TOWER SPACING

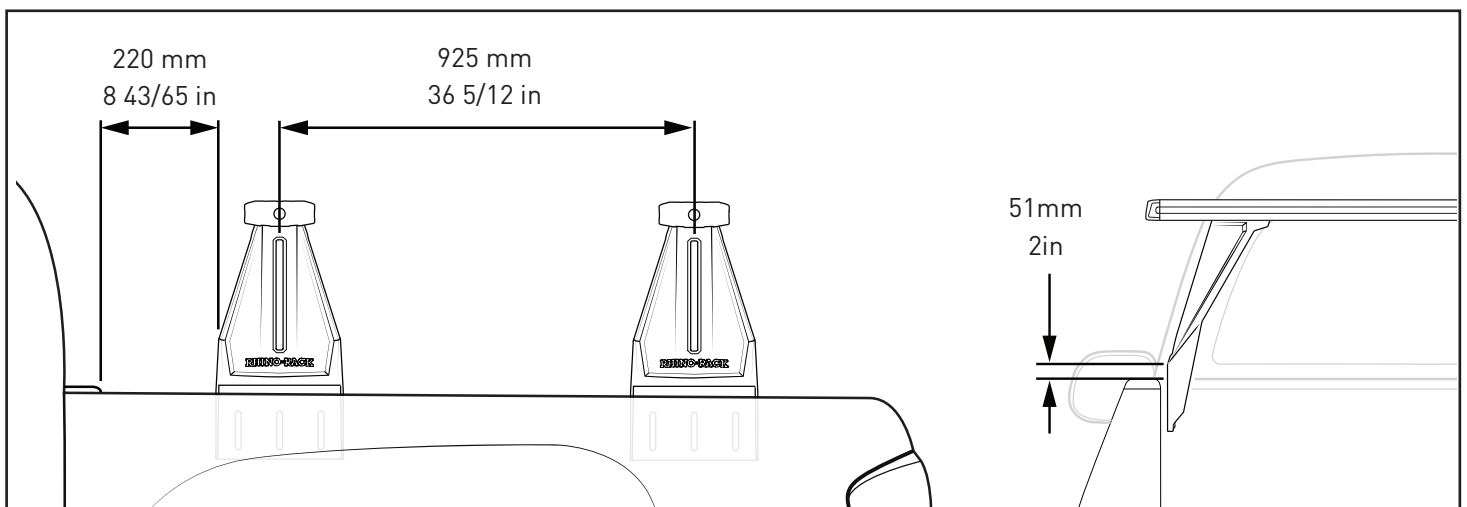

After positioning Towers, return to Reconn-Deck Tower Instruction.

## NOTES FOR DEALERS / FITTERS

It is your responsibility to ensure these fitting instructions are given to the end user or client.